















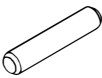

Aufbau mit 2 Personen



40 min



A	B	C	D	E	F	G	H	I
Ø10x50	M6x100	M6x10x13	N 4	3.5x35	M6x90	M6x130	Ø16x75	M6x8x15
								
x50	x27	x28	x1	x30	x1	x1	x4	x2
J	K	O	P	Q	R	S		
6.3x70	4x60	D 8	D 10	D16x20	Ø10x45	6,3x105		
								
x20	x10	x6	x16	x5	x8	x4		

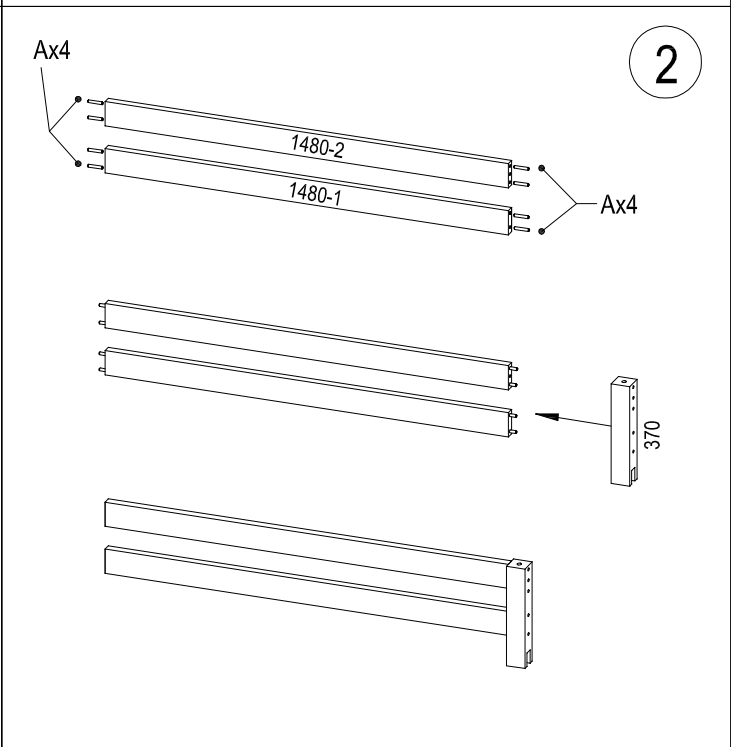
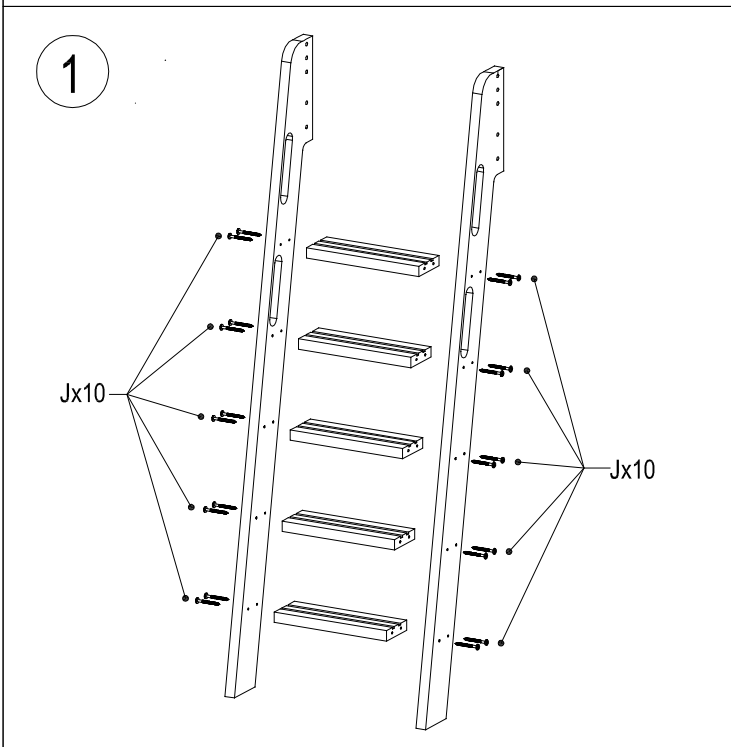
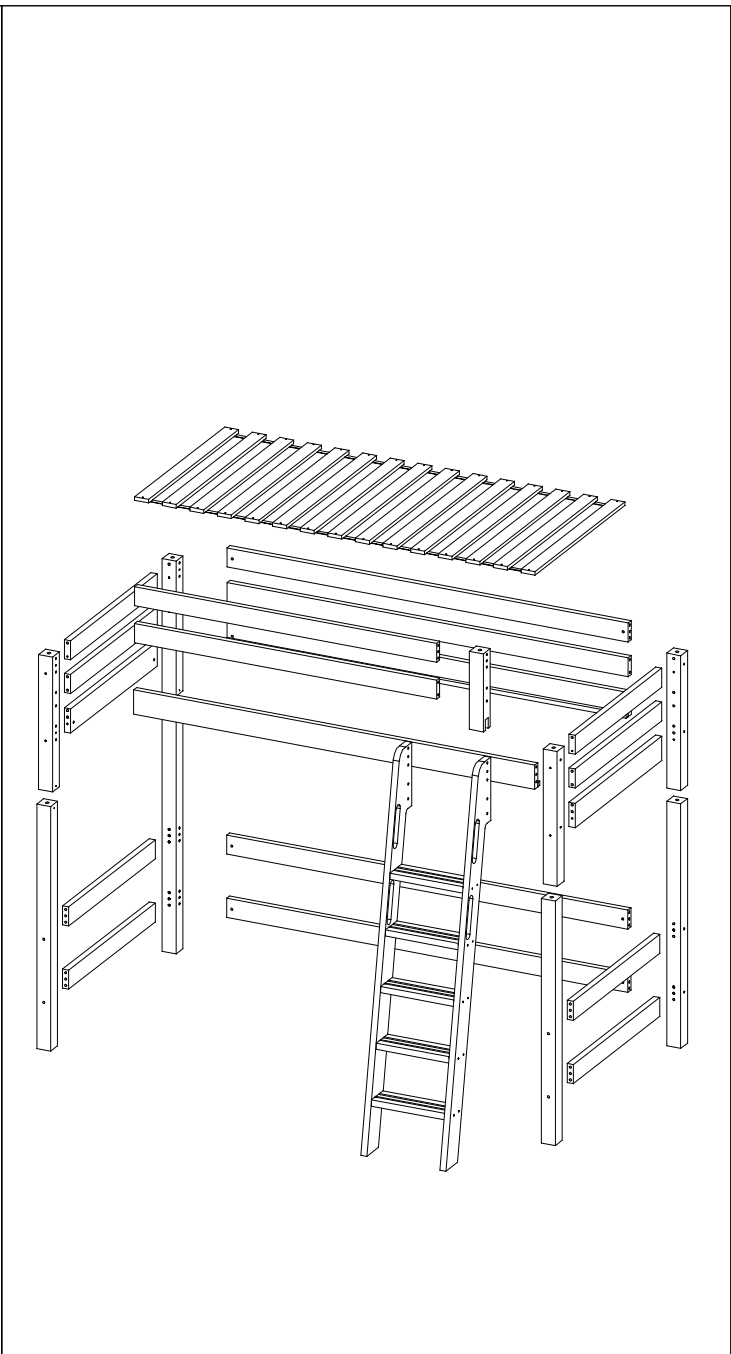
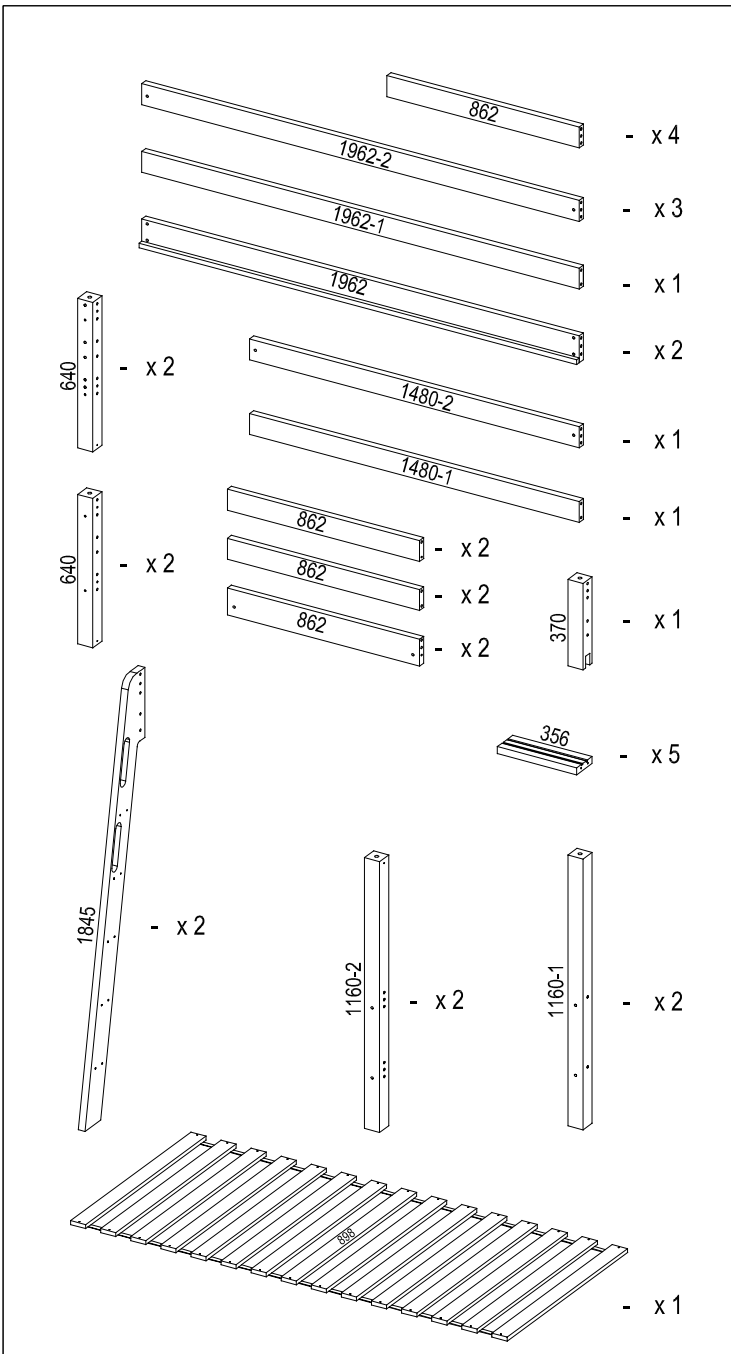

3

2x

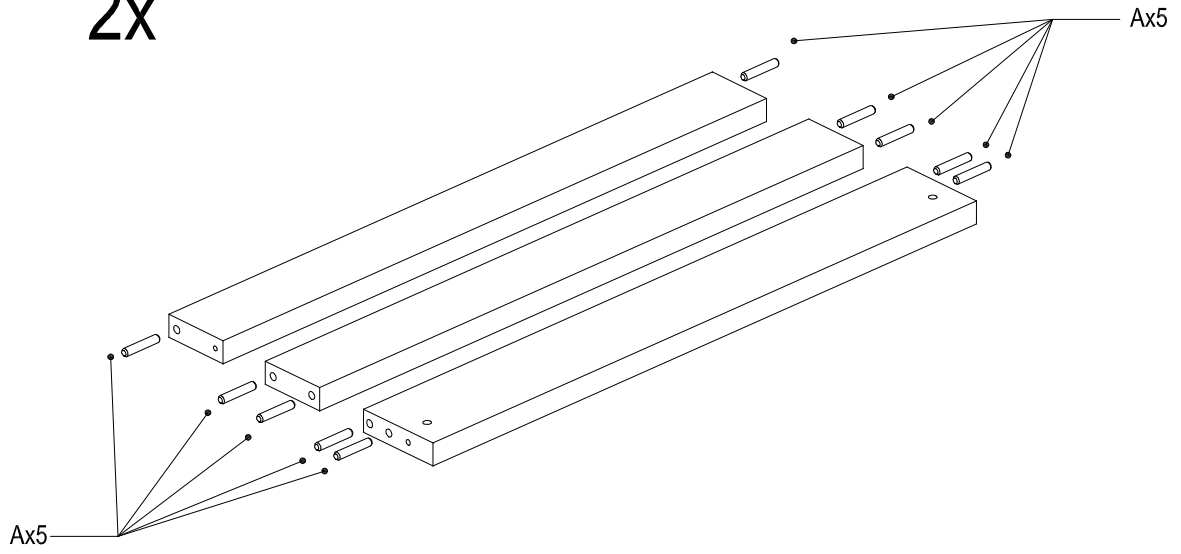

4

2x

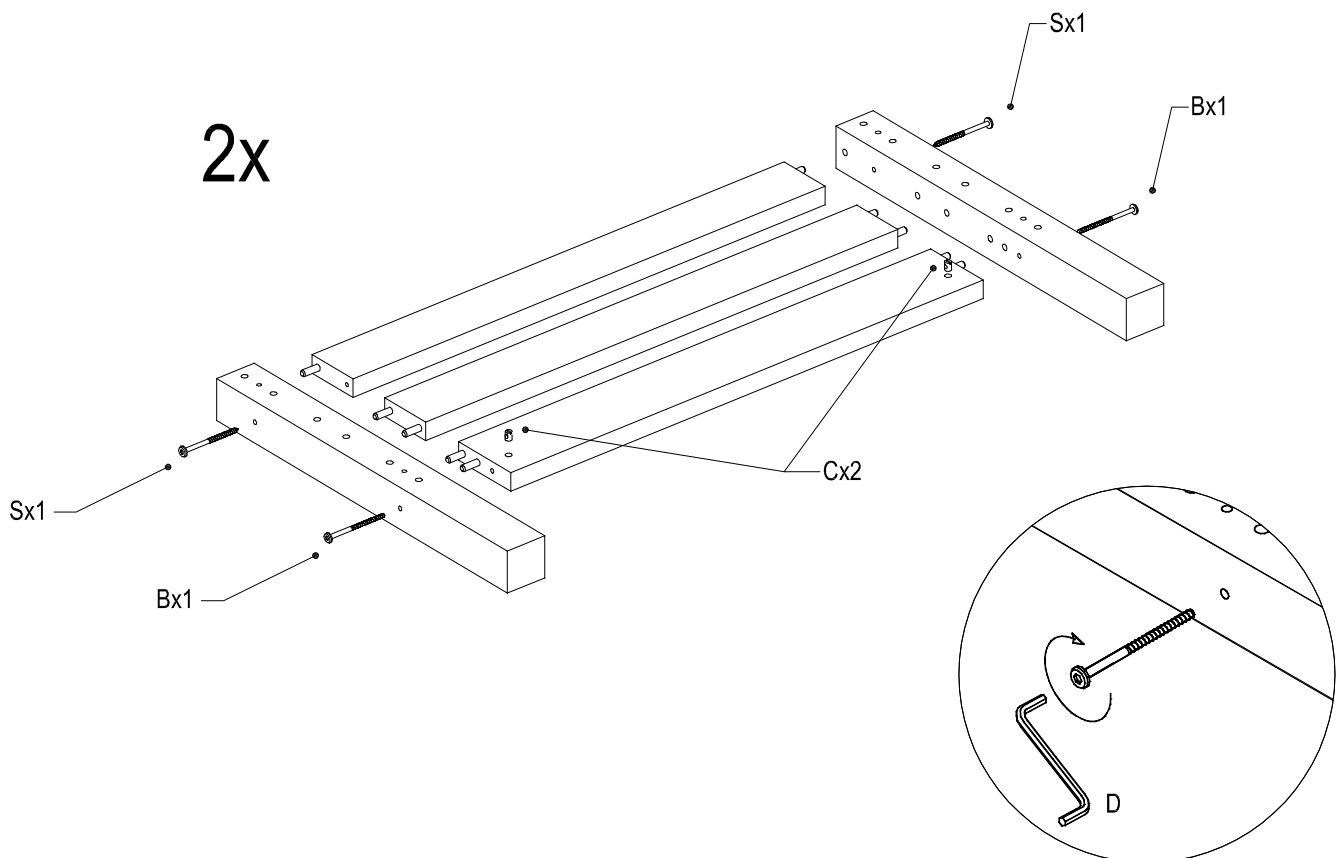

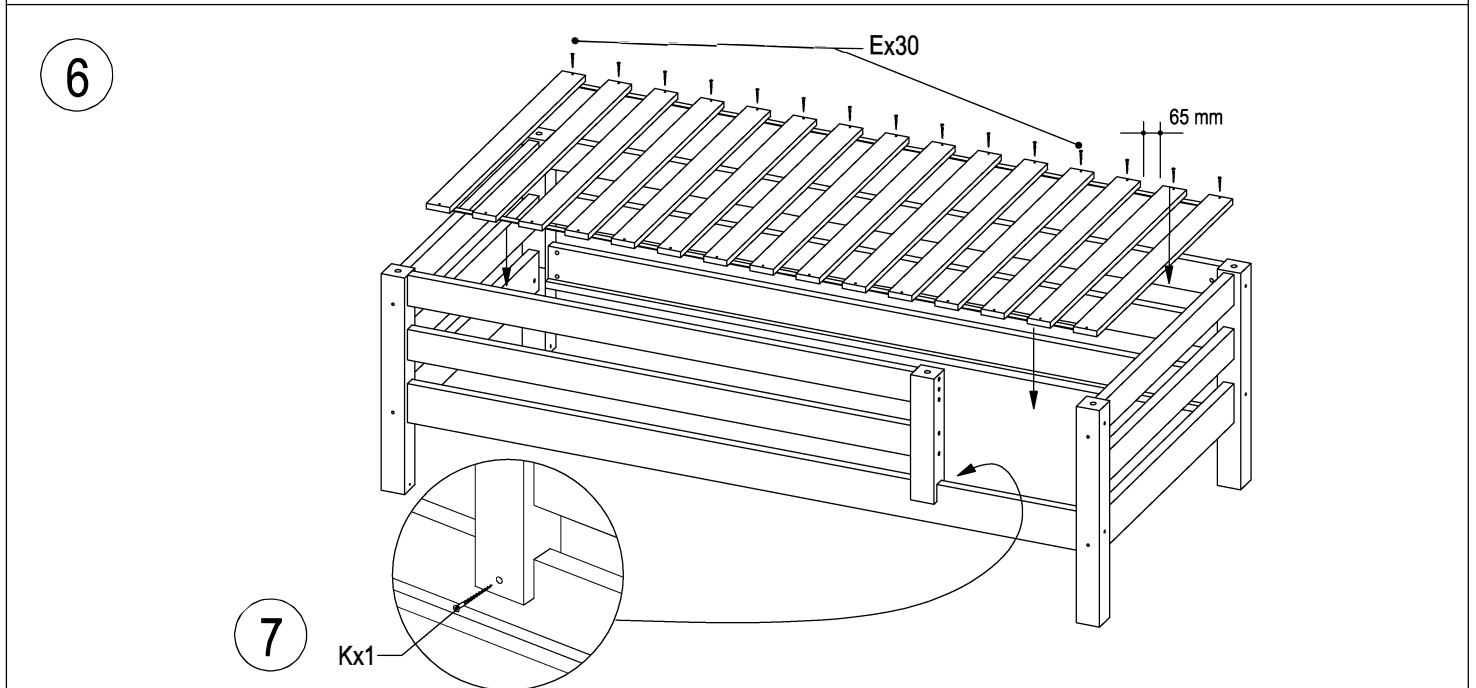
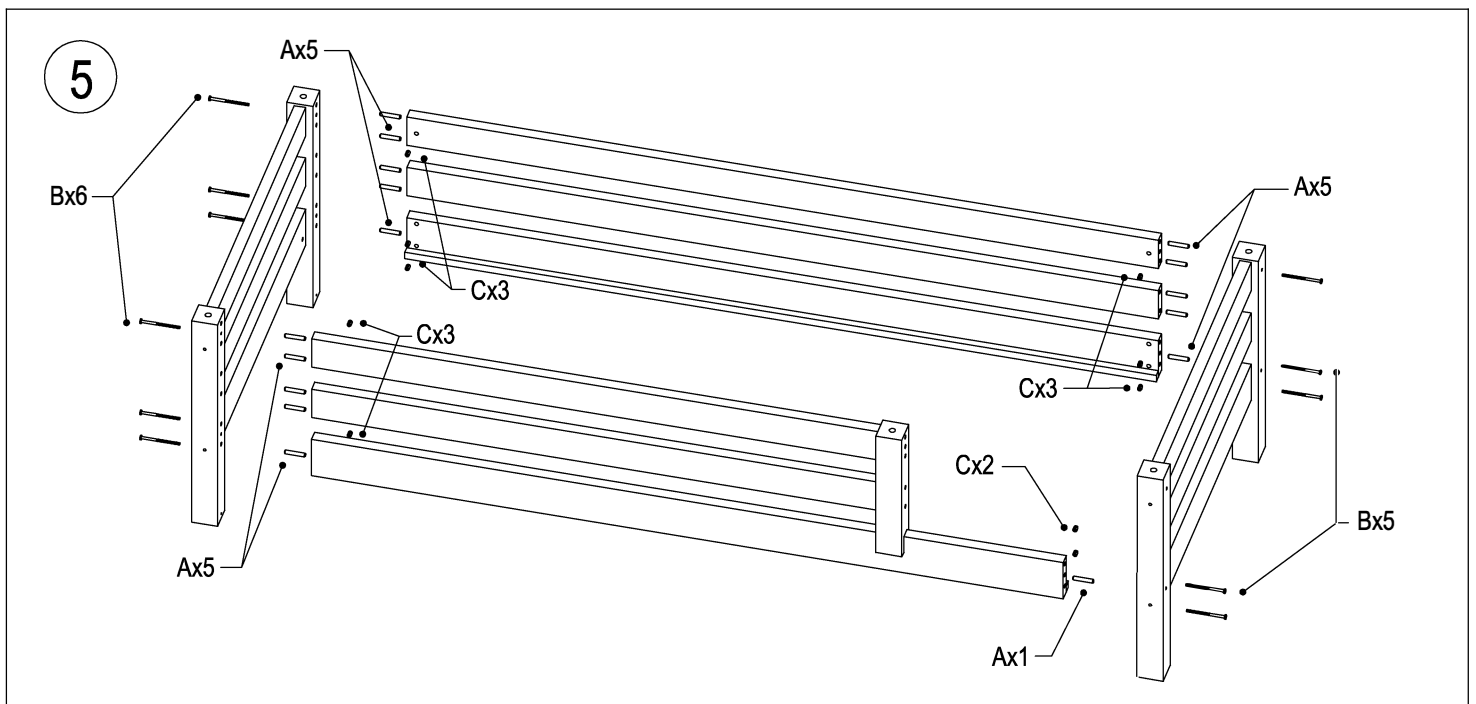

Bei Montage des Lattenrostes die erste und die letzte Leiste bis an die Pfosten herschieben und alle Leisten festschrauben.

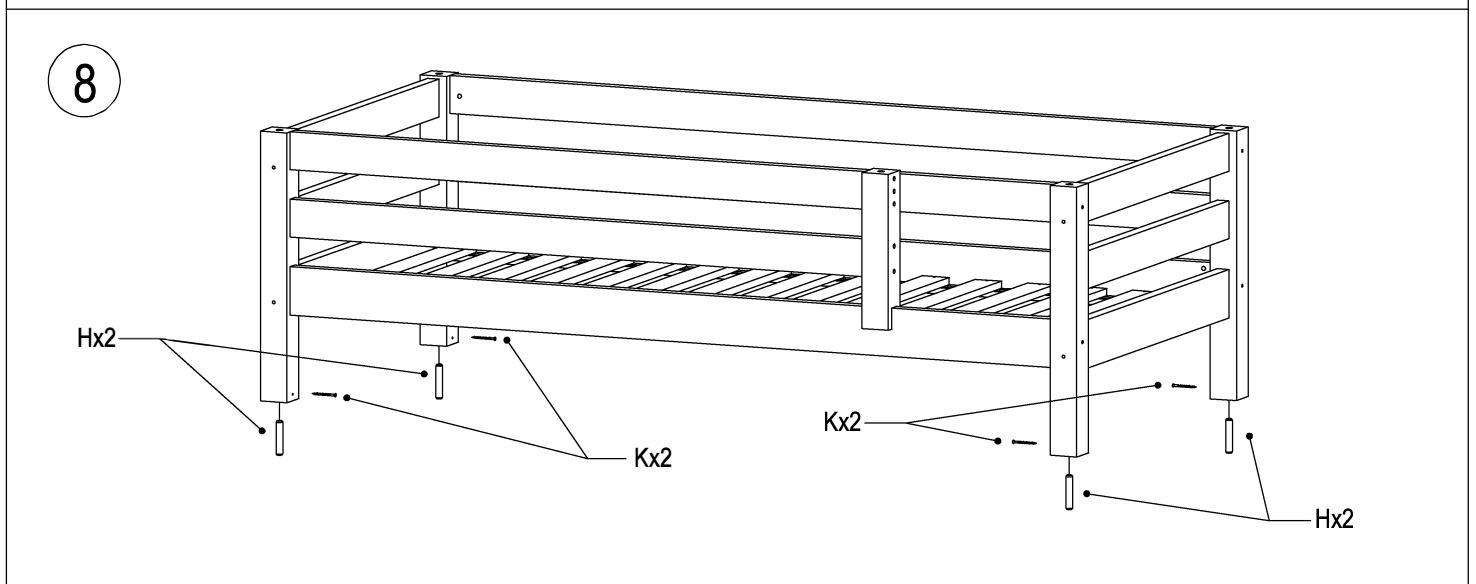

9

- x 2

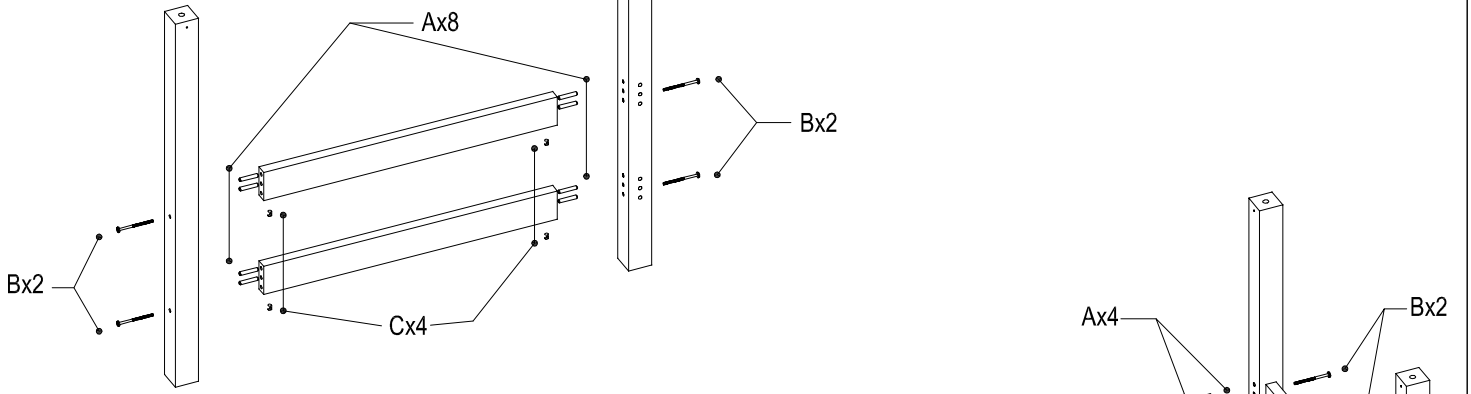

10

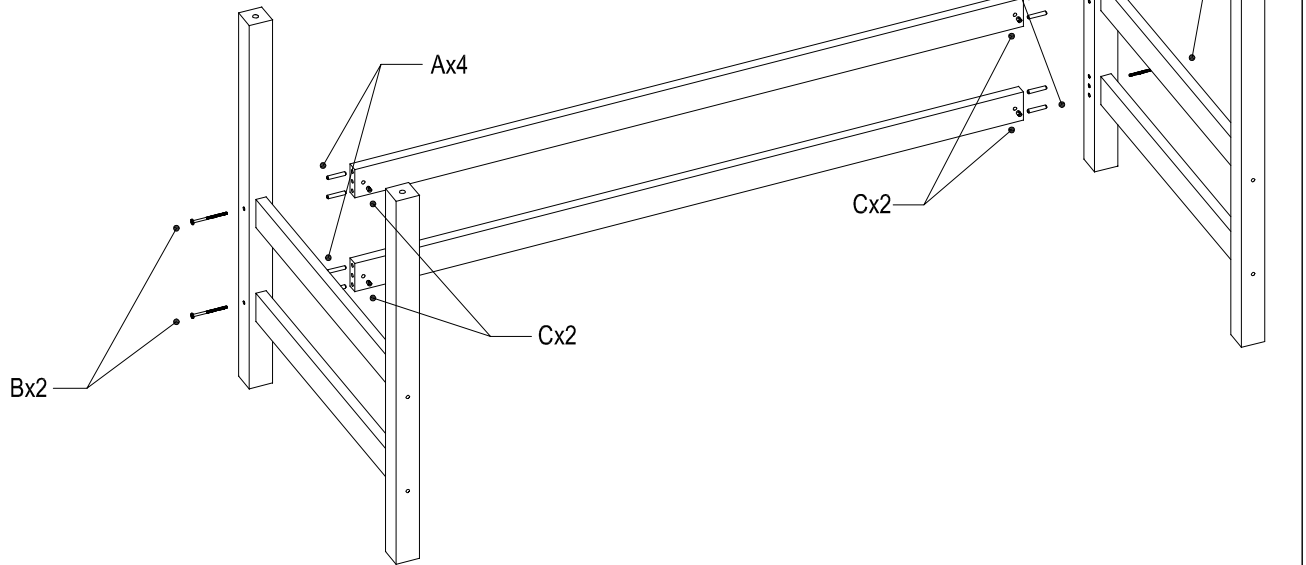

11

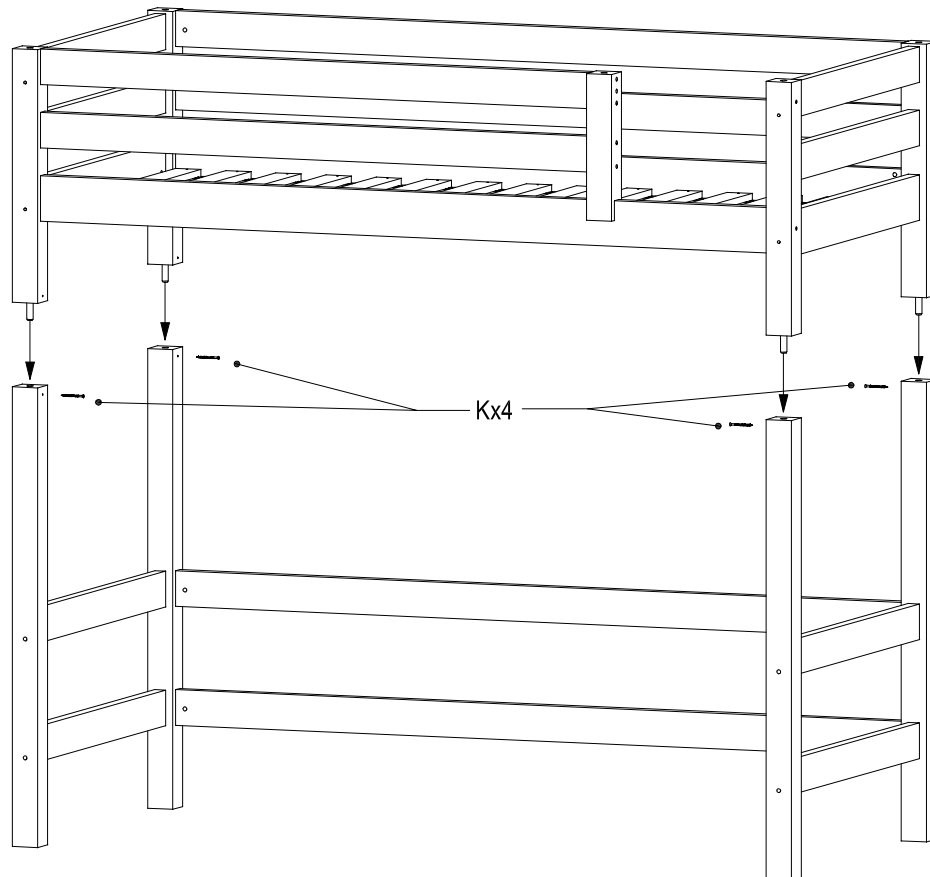

12

